

1

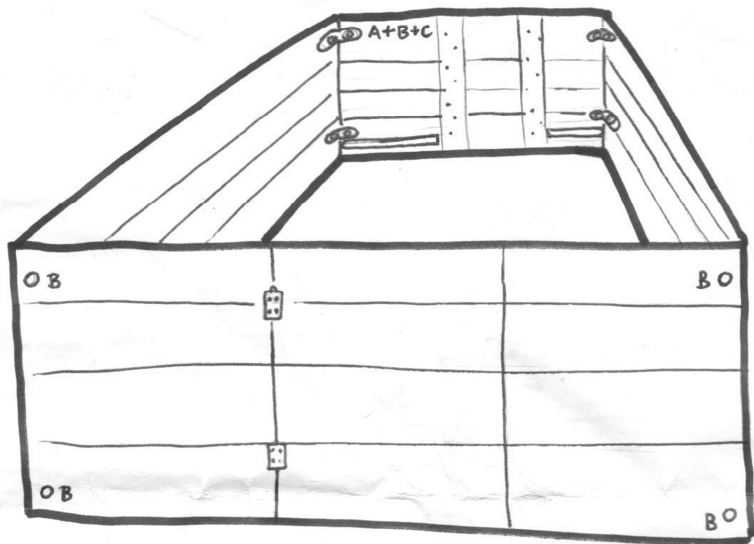

2

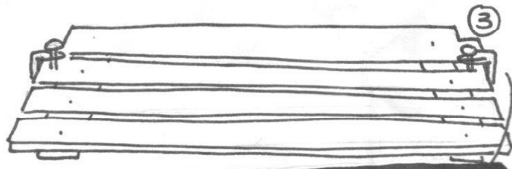

! ① → ② → ③

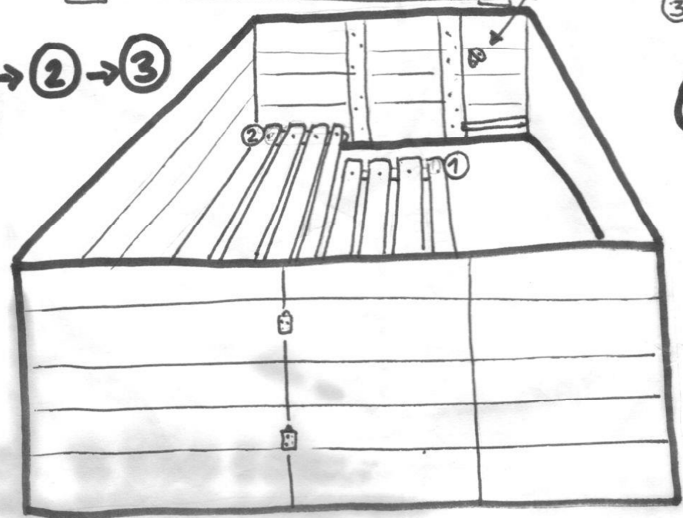



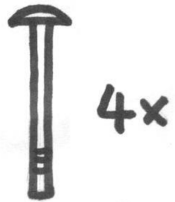
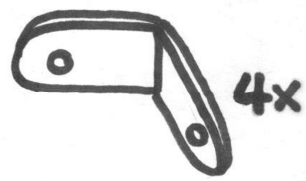

- ① PODLAŽKA
- ② POLICE POD POSTELE
- ③ POSTELE

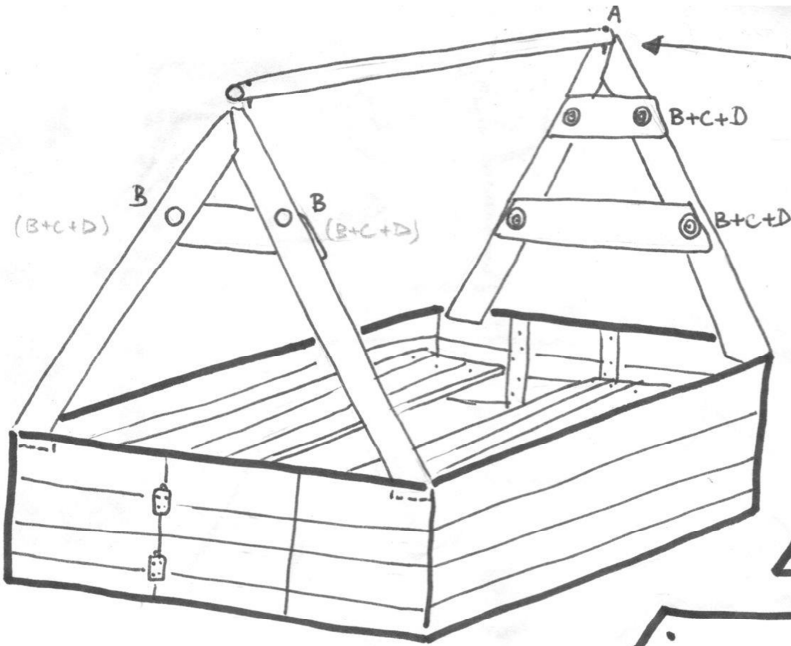

3



- A 2x 
- B 6x 
- C 6x 
- D 6x 



4

